

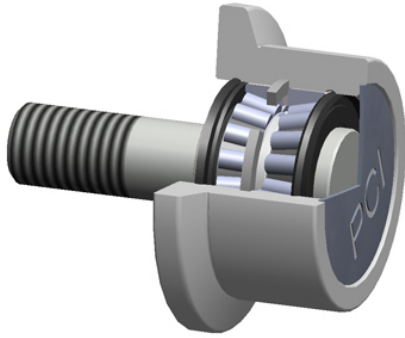

Sealmaster BEARING LTD



PCI Procal Inc. FTR-3.25 Flanged Cam Followers

Bearing No. FTR-3.25

roller diameter:	3.2500 in
roller material:	Chrome Steel
roller width:	2.0000 in
bearing element:	Tapered Rollers
D	4.1875 in
roller shape:	Single Flanged
flange thickness:	0.5930 in
closure type:	Double Seal
stud diameter:	1.2500 in
radial dynamic load capacity:	14300 lbs
thread size:	1-1/4-12
radial static load capacity:	20000 lbs
stud length:	2.5000 in
technical specifications:	Click here

FTR-3.25 Bearing 2D drawings and 3D CAD models