

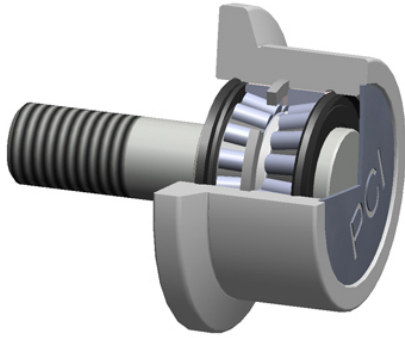

Sealmaster BEARING LTD



PCI Procal Inc. FTR-8.00 Flanged Cam Followers

Bearing No. FTR-8.00

roller diameter:	8.0000 in
roller material:	Chrome Steel
roller width:	3.0000 in
bearing element:	Tapered Rollers
D	8.9375 in
roller shape:	Single Flanged
flange thickness:	0.7180 in
closure type:	Double Seal
stud diameter:	2.5000 in
radial dynamic load capacity:	35830 lbs
thread size:	2-1/2-12
radial static load capacity:	56200 lbs
stud length:	5.5000 in
technical specifications:	Click here

FTR-8.00 Bearing 2D drawings and 3D CAD models